



Bajonett Steckverbinder *Bayonet connectors*

Kabelsteckverbinder

- Steckverbinder mit schneller Bajonett-Verriegelung
- Schutzart IP40 ¹⁾
- Kabeldurchlass in 2 Größen
- Kabelverschraubung mit integrierter Zugentlastung
- Steckverbinder Durchmesser 12mm

Cable Connector

- Connector with easy bayonet locking
- Degree of protection IP40 ¹⁾
- Cable outlet in 2 sizes
- Cable housing with integrated strain relief
- Connector diameter 12mm

¹⁾Erläuterung der Schutzarten siehe Seite TI-3 - TI-4. / ¹⁾Explanation of protection standards see page TI-3 - TI-4.



Aufbau des Steckverbinders:
Construction of the connector:

Kabelstecker
Male cable connector

Kabeldose
Female cable connector

Flanschsteckverbinder
Socket connectors

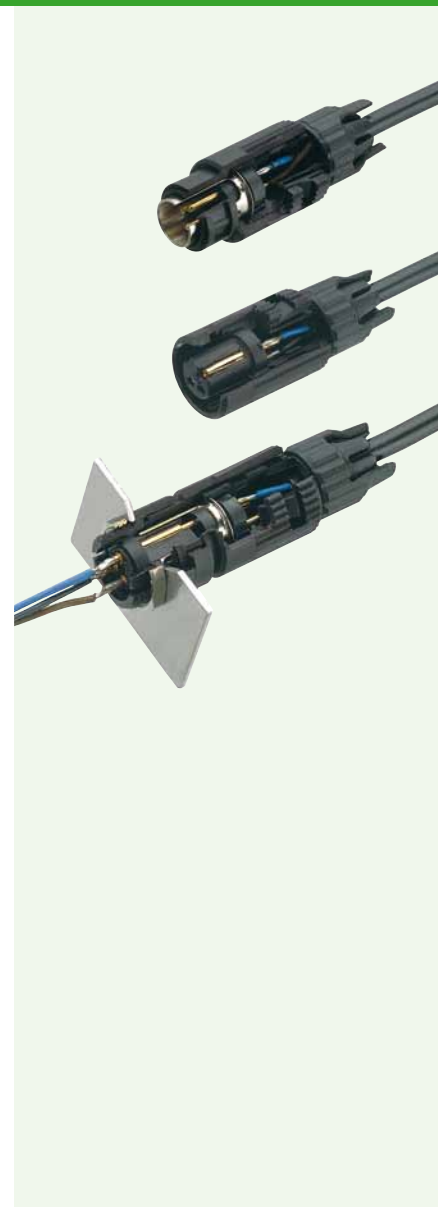

- SI IP40
- SI IP67
- Bajonett
- MPP IP67
- PP IP67
- M9 IP40
- M9 IP67
- SI IP67
- Bajonett
- NCC
- PP IP67
- M16 IP40
- M16 IP67
- M23
- Bajonett
- M25
- RD24
- RD30
- M5
- M8
- M12-A
- VL
- Verteiler
- M12-B
- M12-D
- M12-S
- M12-T
- M12-US
- M18
- 7/8"
- BF-A
- BF-B
- BF-C

Subminiatursteckverbinder Serie 710 Subminiature connectors series 710

Bezeichnung
Description

Kabelstecker
Male cable connector

Kabeldose
Female cable connector

Abbildung
Figure



Maßzeichnung
Drawing

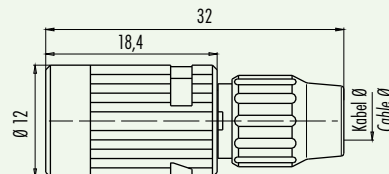
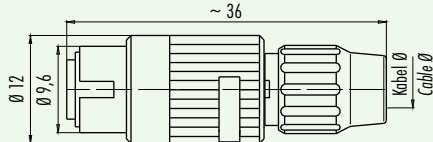

Bestell-Nr.
Ordering-No.

Polzahl Contacts	Kabeldurchlass 3-4 mm Cable outlet 3-4 mm	Kabeldurchlass 4-5 mm Cable outlet 4-5 mm	Polzahl Contacts	Kabeldurchlass 3-4 mm Cable outlet 3-4 mm	Kabeldurchlass 4-5 mm Cable outlet 4-5 mm
2	99 0971 100 02	99 0971 102 02	2	99 0972 100 02	99 0972 102 02
3	99 0975 100 03	99 0975 102 03	3	99 0976 100 03	99 0976 102 03
4	99 0979 100 04	99 0979 102 04	4	99 0980 100 04	99 0980 102 04
5	99 0995 100 05	99 0995 102 05	5	99 0996 100 05	99 0996 102 05
7	99 9475 100 07	99 9475 102 07	7	99 9476 100 07	99 9476 102 07
8	99 9479 100 08	99 9479 102 08	8	99 9480 100 08	99 9480 102 08

Technische Daten
Specifications

Polzahl	2	3	4	5	7	8	Number of contacts
Steckverbinder Verriegelung	Bajonett/bayonet						Connector locking system
Anschlussart	löten/solder						Termination
Anschlussquerschnitt	max. 0,25 mm ² (max. AWG 24)			max. 0,14 mm ² (max. AWG 26)			Wire gauge
Kabeldurchlass	3-4 mm/4-5 mm						Cable outlet
Schutzart	IP40						Degree of protection
Mechanische Lebensdauer	> 500 Steckzyklen/> 500 mating cycles						Mechanical operation
Obere Grenztemperatur	+ 85 °C						Upper temperature
Untere Grenztemperatur	- 40 °C						Lower temperature
Bemessungsspannung	125 V						Rated voltage
Bemessungs-Stoßspannung	1500 V						Rated impulse voltage
Verschmutzungsgrad	1						Pollution degree
Überspannungskategorie	II						Overvoltage categorie
Isolierstoffgruppe	III						Material group
Bemessungsstrom (40 °C)	4 A		3 A		1 A		Rated current (40 °C)
Durchgangswiderstand	≤ 3 mΩ						Contact resistance
Material Kontakt	Stift/pin CuZn (Messing/brass), Buchse/socket CuSn (Bronze/bronze)						Material of contact
Kontaktoberfläche	Au (Gold/gold)						Contact plating
Material Kontaktkörper	PA (UL 94 V-0)						Material of contact body
Material Gehäuse	PA (UL 94 HB)						Material of housing

Subminiatursteckverbinder Serie 710
Subminiature connectors series 710

Einzelteildarstellung
 Component part drawing

Kabelstecker
 Male cable connectors

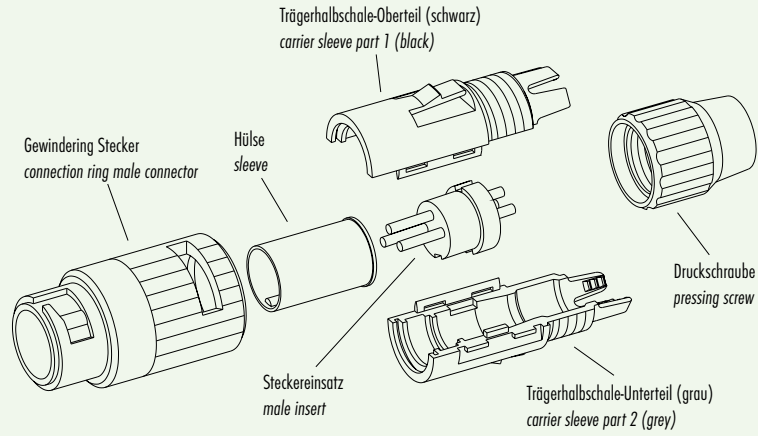

Kabeldose
 Female cable connectors

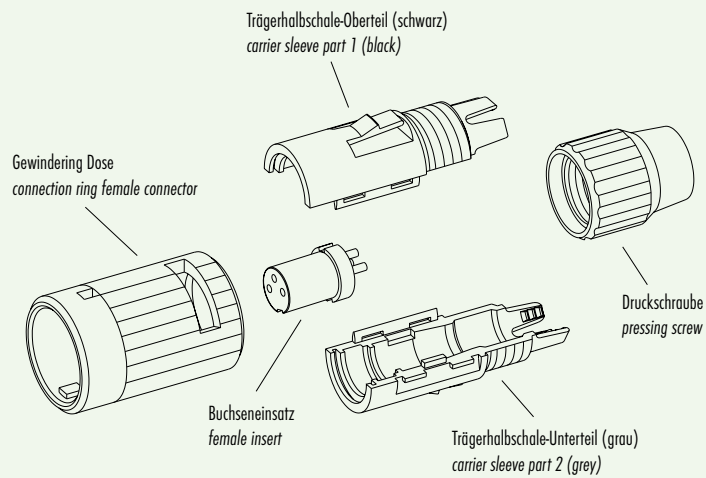

Subminiatursteckverbinder Serie 710 Subminiature connectors series 710

Bezeichnung
Description

Flanschstecker
Male panel mount connector

Flanschdose
Female panel mount connector

Abbildung
Figure



Maßzeichnung
Drawing

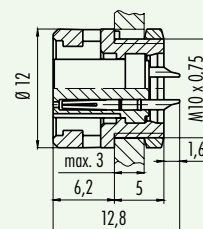
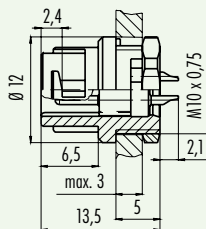

Bestell-Nr.
Ordering-No.

Polzahl Contacts	Bestell-Nr. Ordering-No.
2	09 0973 00 02
3	09 0977 00 03
4	09 0981 00 04
5	09 0997 00 05
7	09 9477 00 07
8	09 9481 00 08

Polzahl Contacts	Bestell-Nr. Ordering-No.
2	09 0974 00 02
3	09 0978 00 03
4	09 0982 00 04
5	09 0998 00 05
7	09 9478 00 07
8	09 9482 00 08

Technische Daten
Specifications

Polzahl	2	3	4	5	7	8	
Steckverbinder Verriegelung	Bajonett/bayonet						Number of contacts
Anschlussart	löten/solder						Connector locking system
Anschlussquerschnitt	max. 0,25 mm ² (max. AWG 24)			max. 0,14 mm ² (max. AWG 26)			Termination
Kabeldurchlass	-						Wire gauge
Schutzart	IP40						Cable outlet
Mechanische Lebensdauer	> 500 Steckzyklen/>5100 mating cycles						Degree of protection
Obere Grenztemperatur	+ 85 °C						Mechanical operation
Untere Grenztemperatur	- 40 °C						Upper temperature
Bemessungsspannung	125 V						Lower temperature
Bemessungs-Stoßspannung	1500 V						Rated voltage
Verschmutzungsgrad	1						Rated impulse voltage
Überspannungskategorie	II						Pollution degree
Isolierstoffgruppe	III						Overvoltage categorie
Bemessungsstrom (40°C)	4 A		3 A		1 A		Material group
Durchgangswiderstand	≤ 3 mΩ						Rated current (40 °C)
Material Kontakt	Stift/pin CuZn (Messing/brass), Buchse/socket CuSn (Bronze/bronze)						Contact resistance
Kontaktoberfläche	Au (Gold/gold)						Material of contact
Material Kontaktkörper	PA (UL 94 V-0)						Contact plating
Material Gehäuse	PA (UL 94 HB)						Material of contact body
							Material of housing

Subminiatursteckverbinder Serie 710 Subminiature connectors series 710

Polbilder
Contact arrangements

Stifteinsatz (Steckseite)
Male insert (mating side)

Buchseinsatz (Steckseite)
Female insert (mating side)

2 pol
2 contacts

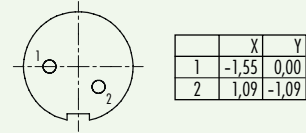
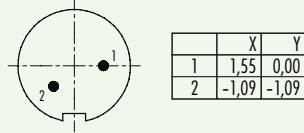

3 pol
3 contacts

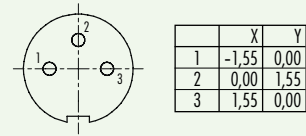
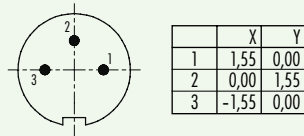

4 pol
4 contacts

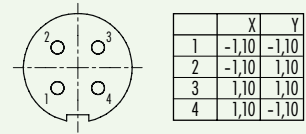
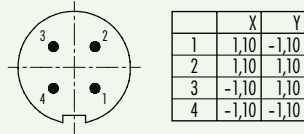

5 pol
5 contacts

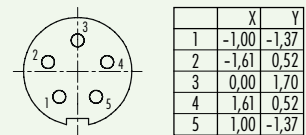
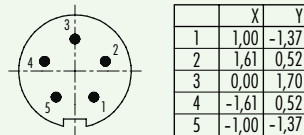

7 pol
7 contacts

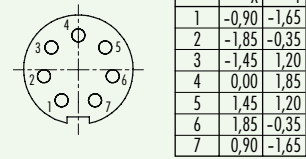
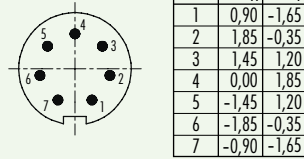

8 pol
8 contacts

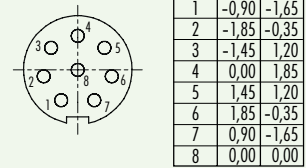
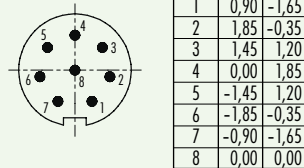

Montageausschnitt
Panel cut out

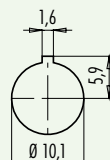

Subminiatursteckverbinder Serie 710
Subminiature connectors series 710

Zubehör
Accessories

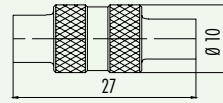
<p>Bezeichnung Description</p>	<p>Montageschlüssel Mounting spanner</p> 	
<p>Abbildung Figure</p>		
<p>Maßzeichnung Drawing</p>	<p>Bestell-Nr. Ordering-No.</p> <p>01 5059 001</p>	<p>Bestell-Nr. Ordering-No.</p>

- SI IP4
- SI IP67
- Bajonett
- MPP IP67
- PP IP67
- M9 IP40
- M9 IP67
- SI IP67
- Bajonett
- NCC
- PP IP67
- M16 IP40
- M16 IP67
- M23
- Bajonett
- M25
- RD24
- RD30
- M5
- M8
- M12-A
- VL
- Verteiler
- M12-B
- M12-D
- M12-S
- M12-T
- M12-US
- M18
- 7/8"
- BFA
- BF-B
- BF-C

